

BANLAW REFUELLING

BANLAW REMOTE FILTERED BREATHER

Thank you for purchasing this high quality Banlaw product. Please read and understand the information in this Product Data Sheet (PDS) **BEFORE** installation or operation of the product to avoid potentially serious health safety & environment (HS&E) risks or property damage.

1 PRODUCT DESCRIPTION

Banlaw Remote Filtered Breathers can be used with a range of liquid storage tanks, including diesel tanks. These Breathers incorporate a 3µm (abs.) air filter to remove airborne particles from airflow *entering* the tank via the tank vent(s). This level of filtration is recommended for fuel tanks onboard modern diesel-powered equipment to comply with OEM requirements.

The Remote Filtered Breathers offer advantages as a means of providing air filtration to *existing* tank vent systems, or *new* venting systems that do not have an integrated filter such as the Banlaw FillSafe™ Zero “vented” level sensors (BVLS series).



Figure 1 - BRFB01A

2 KEY RESTRICTIONS ON THE USE OF THIS PRODUCT



1. The Banlaw Remote Filtered Breather is unsuitable for use with fluids or substances whose properties may affect the safety, function, or reliability of the product. Please consult with Banlaw to confirm fluid compatibility if in doubt.
2. The Banlaw Remote Filtered Breather is manufactured with **external aluminium** and is typically unsuitable for use in underground coal mines, or areas where the use of external aluminium components are prohibited.
3. Safe operation of the Remote Filtered Breather **requires** effective means to prevent bulk fuel flow through the Breather and tank over pressurization be installed. During tank overfill large flows of diesel through the Filter Breather can create excessive pressures which may exceed the safe working pressure (SWP) of a tank.
4. The resistance to exhaust airflow through a Banlaw Remote filtered breather may influence the operation of a tank refuelling system comprising a (fuel) pressure sensitive automatic shut-off feature – e.g. a Banlaw “quick-fill” system, etc. After installation reconfirm the effective operation of the system, specifically the correct operation of the Nozzle.
5. Inlet and Outlet hoses to the Remote Filtered Breather must be designed and maintained such that they remain unobstructed by:
 - a. Environmental Debris such as Dirt, Mud, and Clay, etc.
 - b. Kinks, Pinch points or Low points.
 - c. Work by-products such as Tape, Rags, “Offcuts”, etc.
6. Inlet and Outlet hoses must be directed a safe distance from sources of heat or any other ignition hazard.
7. Inlet and Outlet hoses must be directed away from personnel.
8. The Banlaw Remote Filtered Breather must be installed and oriented in accordance with the acceptable orientation Guideline as indicated within this document.
9. **To prevent tank damage due to over-pressurisation, the liquid storage tank(s) onto which this Banlaw Filtered Breather is connected must be designed (rated) to;**
 - a. **An internal pressure rating exceeding the maximum expected tank pressure during refuelling/refilling of the tank.**
 - b. **An internal vacuum (i.e. external pressure) rating exceeding the maximum expected tank pressure during decanting (draw down) of liquid from the tank.**



Unless noted otherwise, the Banlaw Remote Filtered Breather (BRFB01A) has not been assessed or subsequently certified under governances that may apply to certain applications of this Breather. End-users shall perform a due diligence assessment of the governances relevant to any proposed application to ensure suitability of use. Such governances may include; Regulations, Standards, Codes, Guidelines, Industry and Regional requirements, etc.

Note:



This Product is unsuitable for use with AdBlue (DEF).

3 DESIGN FEATURES

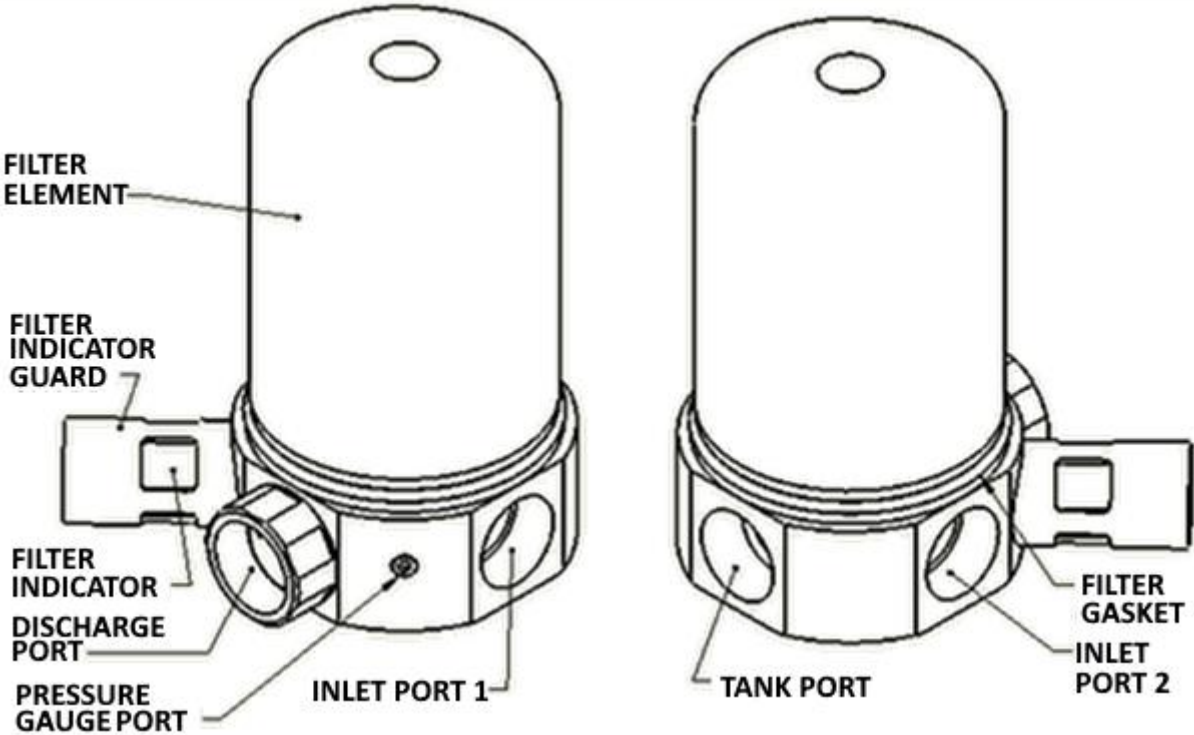

Figure 2 – External Features

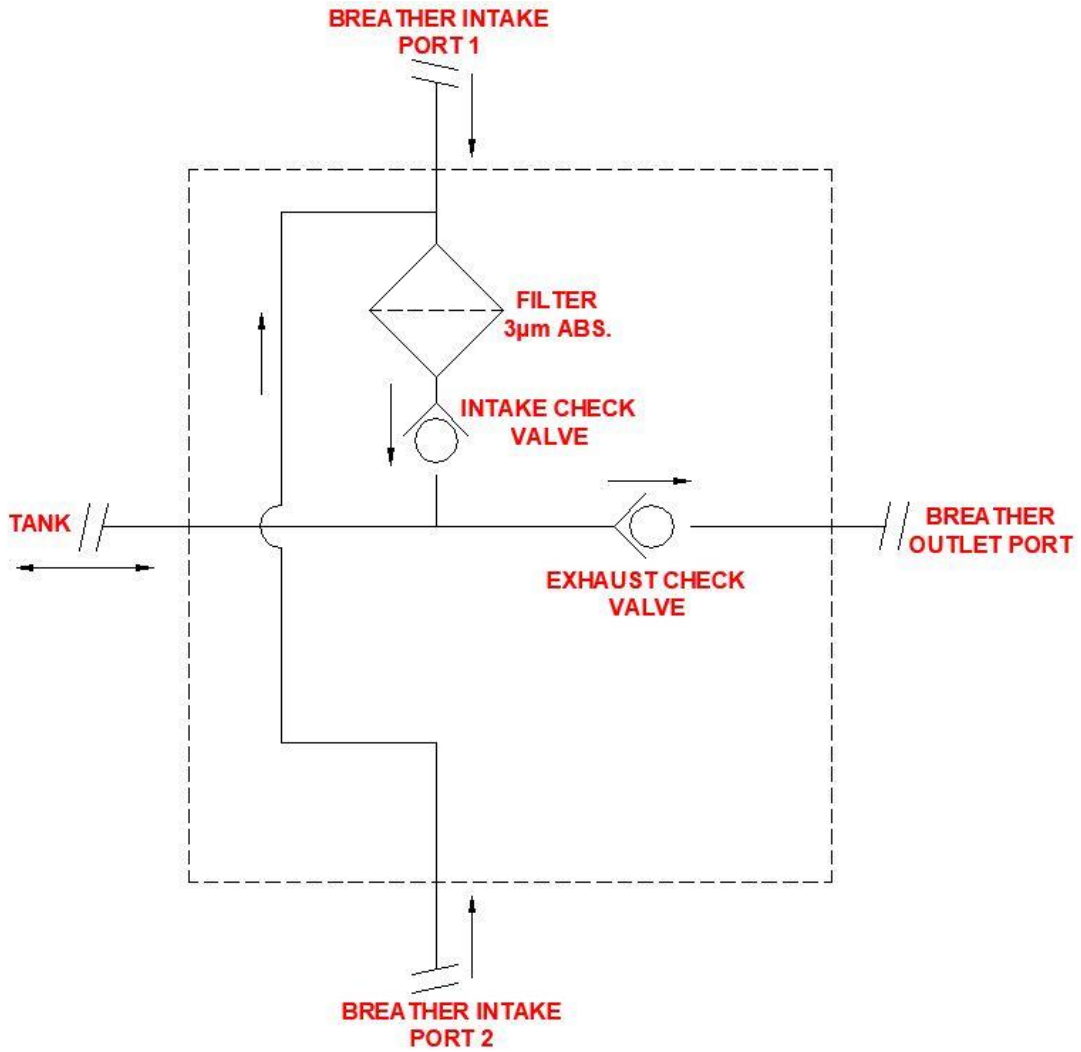

Figure 3 - Basic Flow Schematic of Breather

Figure 3 and Figure 4 illustrate the flow paths through the BRFB01A Breather.

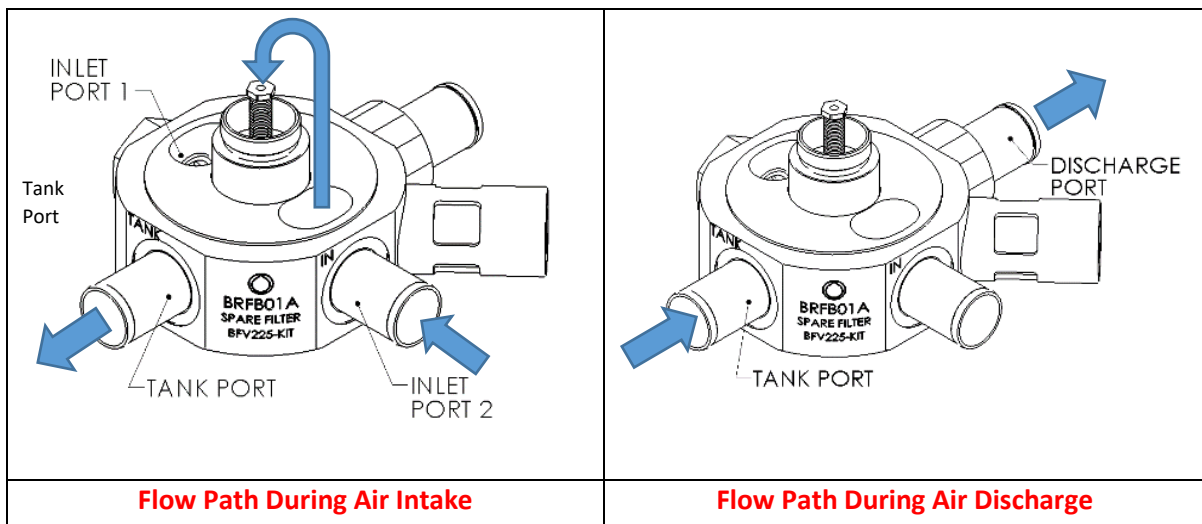

Figure 4 - Internal Flow Paths of the Breather

Design Features provided by the Breathers are as follows:

- **3µm (abs.)** filter element as is found in the Banlaw Fine Filtered Vent (e.g. BFV225, etc.).
- Maximum recommended flowrate of 1000lpm (Air Intake and Discharge).
- Two off internal check valves to ensure;
 - **Outgoing** (effluent) airflow **bypasses** the filter element and is exhausted to atmosphere via the tank exhaust port.
 - **Incoming** (influent) airflow **must pass through the air filter**.
- 1 ¼" Hose Barbs which can be removed to allow for 1" BSPP-F direct hose connection.
- Dual inlet ports to allow for installation flexibility when in routing inlet (tank air intake) to a clean and safe location.
- A gasket between the outer mating surface (circumference) of the "spin-on" filter element casing and the machined surface of the filter inlet plate (flange).
- A "resettable" filter condition indicator to indicate filter pressure drop and provide maintenance feedback on the remaining life of the filter.
- Stainless Steel Filter Indicator Guarding to help protect the indicator from mechanical impact and UV damage.
- A ruggedised construction to suit harsh operating environments. Structural components are of all of metal construction.
- Durable Viton Seals Fluid seals are selected and designed to best suit diesel applications.

4 PRODUCT SPECIFICATIONS

Banlaw Remote Filtered Breather	
Max. Flowrate (Air) LPM (GPM), (CFM) (Exhaust or Intake Airflow)	1000 LPM (264 GPM), (35.3 CFM)
Min. Flow Rate	Not Applicable
Operating Temp. Range °C (°F)	-10°C (14 °F) to 55°C (131°F)
Compatible Fluid Types	Non-Flammable incompressible liquids, e.g. diesel fuels, oils, coolants, etc.
Principal Material Composition	Aluminium, Stainless, Steel, Brass Viton (Seals)
Process Connections	1-1/4" Hose Barb (1" BSPP alternative), 1/8" NPTF pressure indicator
Banlaw Filter Replacement Kit	BFV225-KIT

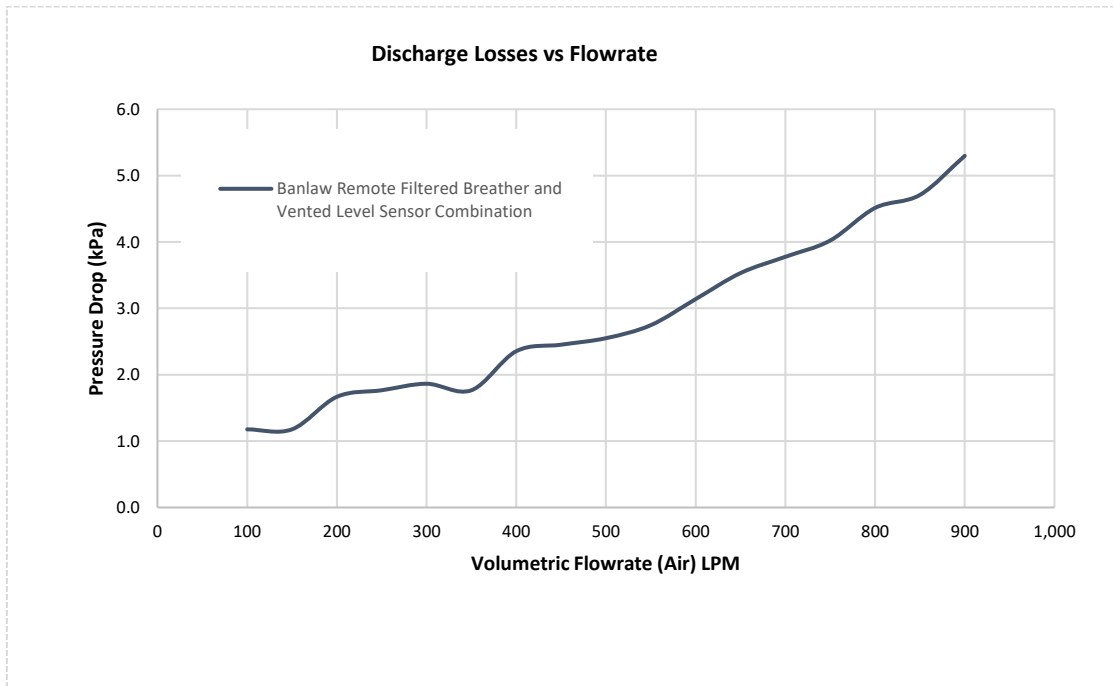

Figure 5 – Pressure Drop during Air Discharge

Figure 5 indicates the pressure drop induced by a Banlaw Remote Filtered Breather, a Banlaw FillSafe Zero Vented Level Sensor and 3m of 1 ¼” (DN31) hose when **venting air to atmosphere** (i.e. tank filling). The flow (passage) of liquid through the Breather will increase the pressure drop. Significant liquid flowrate may cause damage to the Breather and is likely to cause hazards such as over-pressurisation of the tank(s) to which the Breather is connected.

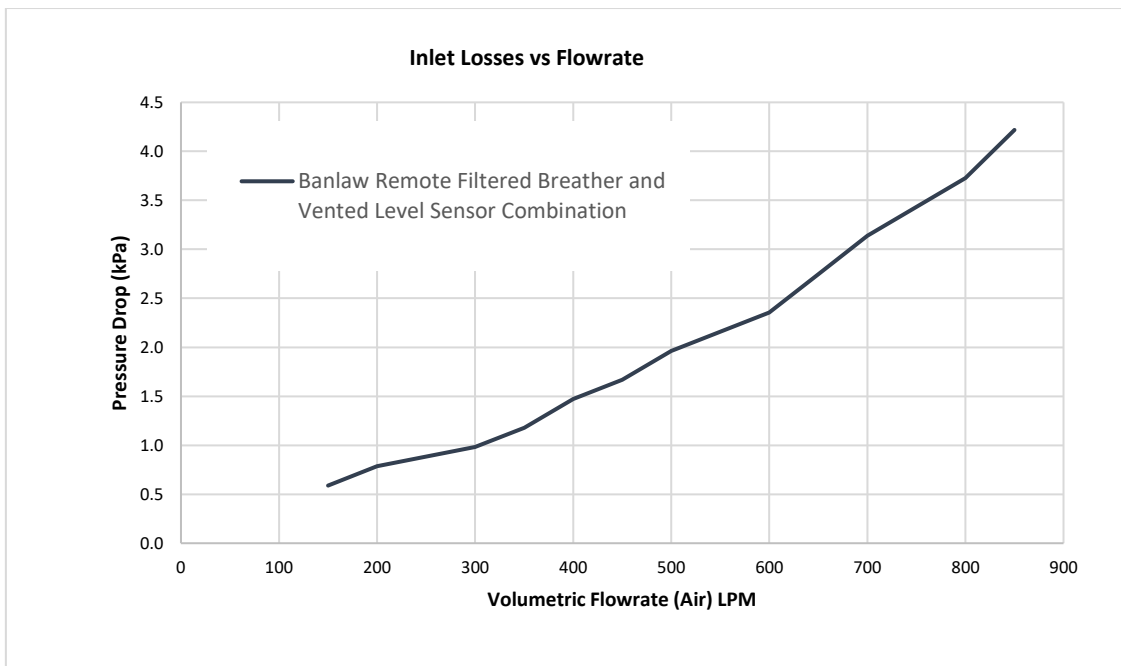

Figure 6 – Pressure Drop during Air Intake (Clean Filter Element)

Figure 6 indicates the pressure drop induced by a Banlaw Remote Filtered Breather, a Banlaw FillSafe Vented Level Sensor and 3m of 1 ¼” (DN31) hose when **filtering atmospheric air via a “new” (i.e. clean) filter element**. Contamination “loading” of the Filter Element will increase the Pressure Drop accordingly. Attention (i.e. filter condition monitoring) of this matter should be made particularly when using the Breather for higher fuel discharge – i.e. intake air flowrate - applications, e.g. bulk storages on-board mobile service vehicles, etc.

5 TYPICAL APPLICATIONS

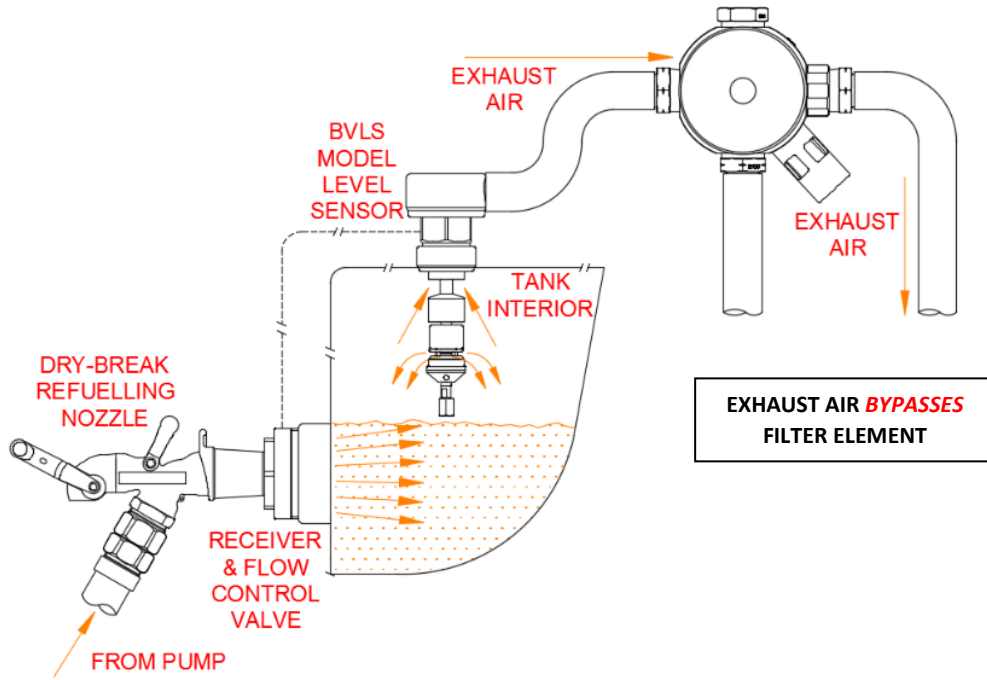

Figure 7 – Tank Refilling (Air Exhaust)

Figure 7 shows a typical refuelling system with tank OFP (Banlaw FillSafe Zero) incorporating a **Banlaw Remote Filtered Breather**. Air discharged from the tank during refuelling bypasses the filter cartridge within the Breather and is vented to atmosphere at a **safe** location.

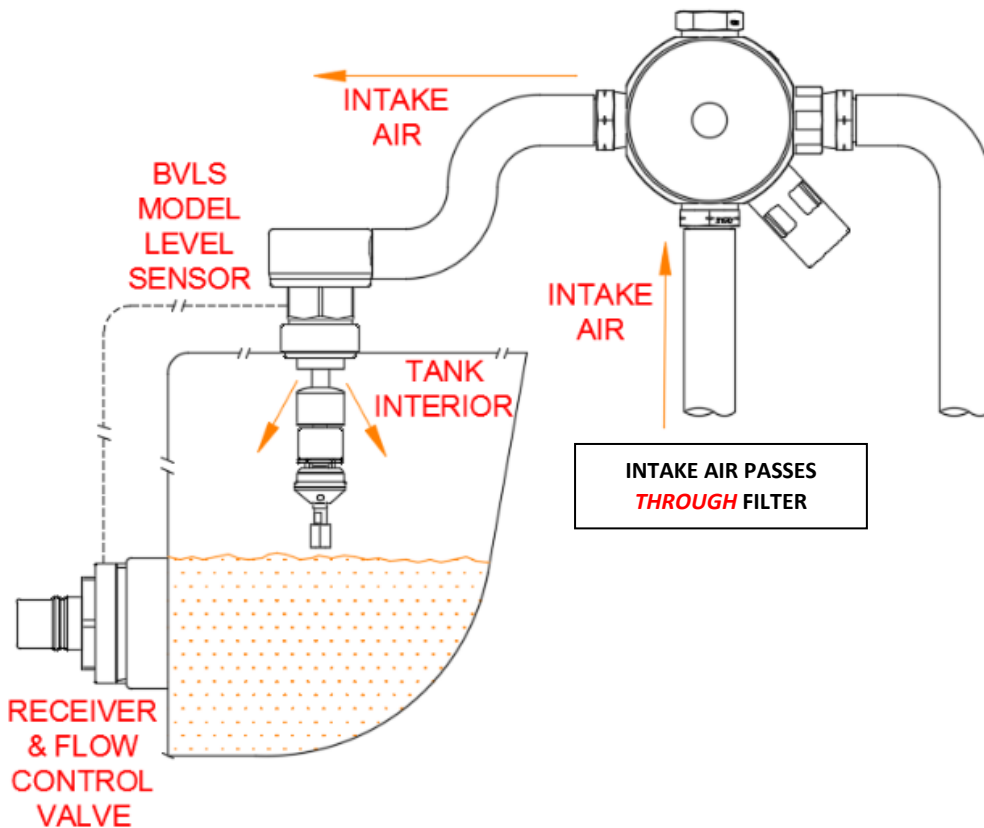

Figure 8 – Air Intake

Figure 8 shows the same setup during fuel discharge. The breather draws air from a safe location, **through the filter element**, then directs it into the tank to equalize tank pressure.

6 INSTALLATION GUIDE

		
		
<p>Poor Arrangement Filter may not drain. Inlet may collect condensate. Outlet check valve may collect condensate.</p>	<p>Poor Arrangement Filter may not drain. Inlet may collect condensate. Outlet check valve will drain freely.</p>	<p>Poor Arrangement Filter may not drain. Inlet may collect condensate. Outlet check valve may collect condensate.</p>
		
<p>Poor Arrangement Outlet check valve may collect condensate. Inlet may collect condensate. Filter may not drain.</p>	<p>Poor Arrangement Filter may not drain. Inlet will drain freely. Outlet will drain freely.</p>	<p>Poor Arrangement Filter may not drain. Inlet may collect condensate. Outlet may collect condensate. Tank port may collect condensate.</p>
		
<p>Acceptable Arrangement Filter will drain. Inlet will not collect condensate. Outlet check valve may collect condensate.</p>	<p>Best Arrangement Filter will drain. Inlet will drain freely. Outlet check valve will drain freely.</p>	<p>Best Arrangement Filter will drain. Inlet will drain freely. Outlet check valve will drain freely.</p>

Figure 9 - Poor & Acceptable Breather Orientations

The Banlaw Remote Filtered Breather is designed with 8 blind-tapped M6 holes to mount through existing plate or equipment walls. Additionally, Banlaw offers several optional mounting kits for the breathers. The mounting holes are designed to match the centre to centre distance of either STAUFF (Group 5) Clamps or STAUFF Elongated Weld Plates (Type SPV - Group 5). These two mounting options are particularly useful when clamping to 32mm (1-¼") or 38mm (1-½") fixed handrail – refer section 6.2.

Each of the 3 hose barb connection points can be replaced with 1" BSPP connections.

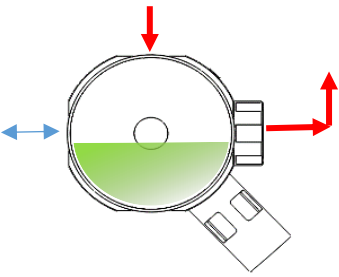
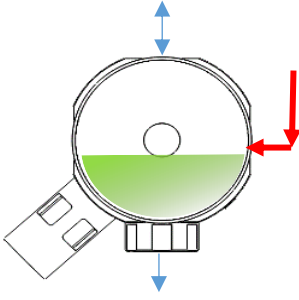
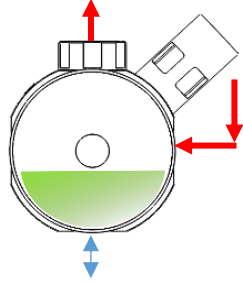
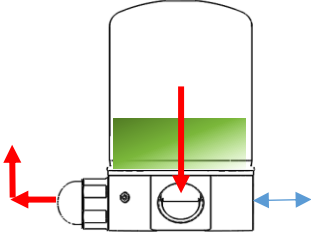
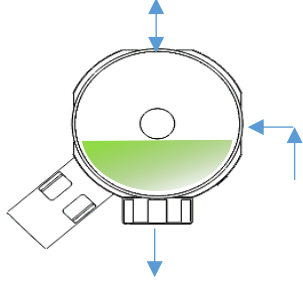
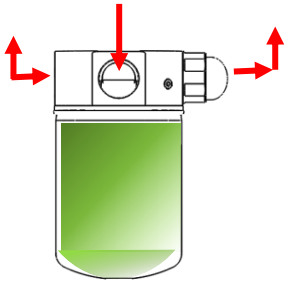
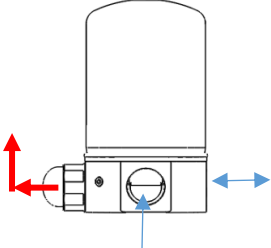
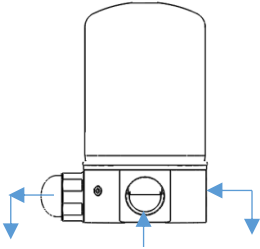
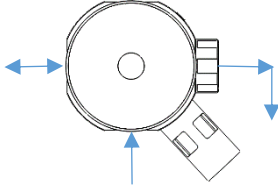
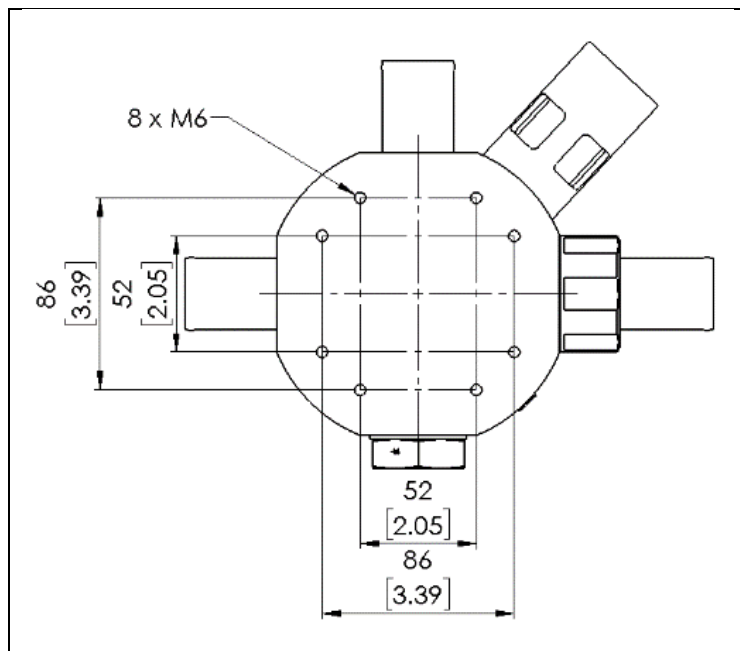

Figure 10 – Breather Mounting Details

The Remote filtered breather is equipped with two *inlet* ports. **In most applications the unused inlet port will be plugged (sealed), however both inlets can be used if desired.**

When installing the Remote filtered breather there are several key considerations:

- Remote Filtered Breather must be securely attached to a structure.
- Safe operation of the Remote Filtered Breather **requires** that an effective means to prevent bulk fuel flow through the Breather and tank over pressurization be installed.
- Pressurized Tank Refuelling Shut off and Overfill Protection systems must be properly maintained and used in a safe manner – i.e. not “Manually Over-Ridden”.
- Breather hoses should be directed to a location where they will be:
 - Conveniently inspected for condition, kinks, and blockages etc.
 - Able to drain out any moisture or condensate collected. (i.e. no u-bends or low points)
 - Directed away from sources of contamination (i.e. mud)
 - Free from obstructions (i.e. kinks, pinches, clogs)
 - Directed away from personnel.
 - Directed a safe distance from sources of heat or any other ignition hazard.
- The Remote filtered breather should be installed in a “high spot” or in such an orientation that any condensate (fuel or atmospheric) collected within the vent hoses will be bled through the internal check valves or away from the Breather. The inlet should be orientated such that any collected condensate within the Filter cartridge can drain through the Internal Inlet Port. Refer to Figure 4 and Figure 9.
- The Remote filtered breather should **not** be installed “Filter Side Down”. Installing the filtered breather in this orientation may cause the filter cartridge to fill up with condensate.

- The Remote filtered breather should be installed such that the filter element and filter level indicator can be easily accessed and inspected.
- Excessive vibration and shock (impact) of the Breather may adversely affect the efficiency of the air filter. The Breather should be installed
- The pair of check valves – intake and exhaust – within the Breather are normally closed. The differential (i.e. “crack”) pressure to open either check valve is less than approximately 3kPa (0.44psi). **When each check valve is fully closed (i.e. sealed), a small residual pressure or vacuum may occur within the tank until either check valve is unseated to allow airflow.** This may create the following scenarios;
 - Inability to *fully* drain a tank until any residual vacuum is released.
 - A minor fuel level imbalance between interconnected tanks.
 - Some inaccuracy of tank volume, level or mass process instrumentation which measure the *pressure* within the tank.

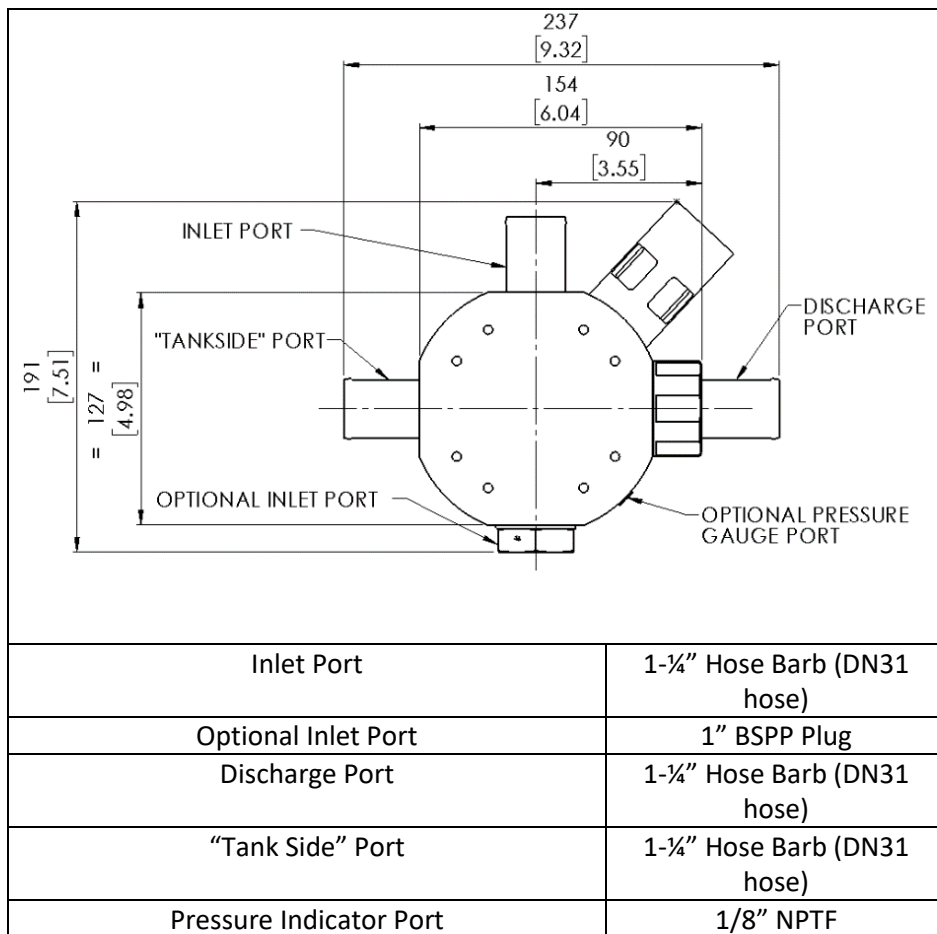

Figure 11 – Process Connections

6.1 Pre-Installation Checklist

1. Confirm the operational requirements comply with the **Breather Product Specifications**.
2. Conduct a Pre-work assessment (i.e. “Take 5” etc.) and fill out a JHA to identify and assess any potential hazards involved in the installation.

6.2 Breather Mounting Kits

Banlaw offers a variety of mounting options (kits) for the BRFB01A as optional accessories.



Figure 12 - BRFBM1

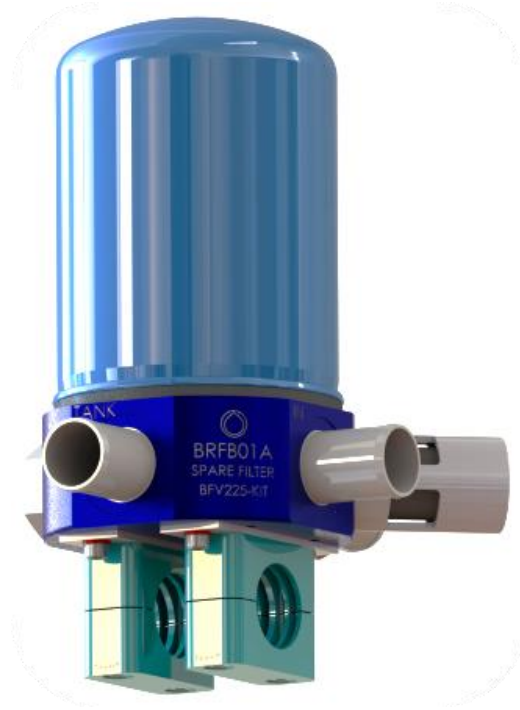

Figure 13 - BRFBM2



Figure 14 - BRFBM3



Figure 15 - BRFBM4

- Figure 12; Universal bracket (mild steel) mounting kit.
- Figure 13; Dual Stauff clamps to suit 1-1/2" (38mm) OD pipe (e.g. handrail).
- Figure 14; Dual Stauff clamps to suit 1-1/4" (32mm) OD pipe (e.g. handrail).
- Figure 15; Four (4) Magnets with stand-offs.

Note:

- Each mounting kit does **not** include the Breather Assembly (BRFB01A). The mounting kit required must be ordered **separately**.
- Each mounting kit is supplied complete with fasteners. Any additional or alternative fasteners shall be supplied by the customer.

6.3 Installation Procedure

1. Complete all necessary hazard mitigation, monitoring and control actions as per the JHA.
2. Mount the Remote Filtered Breather on a solid and reliable attachment point. Refer to the **section 6** for acceptable orientations.
3. Thread in supplied Hose Barb process connection fittings or 1" BSPP alternatives using Loctite or similar thread sealant. If only 1 Inlet Port is used, **plug (seal) the unused inlet port**.
4. Measure and cut breather hose - 1 ¼" (DN31) hose recommended.
5. Using appropriate method, connect and fix Breather hose to the relevant connection fittings;
 - a. **Tank Port** connected to the **Tank Vent(s)**.
 - b. **Inlet Port** connected to **Inlet Hose** routed to a safe, clean, location away from personnel and ignition sources.
 - c. (Optional); Additional Inlet Port connected to auxiliary inlet hose routed to a safe, clean, location away from personnel and ignition sources.
 - d. **Discharge Port** connected to **Discharge Hose** routed to safe, clean location **away from personnel and potential ignition sources**.
 - e. (Optional); **Pressure Port** connected to a pressure instrument (e.g. pressure gauge) located in a sheltered, easily accessible and readable (visible) position.
6. Securely support and fasten all breather hoses to equipment using suitable attachments, e.g. hose clamps, magnetic anchors, Stauff clamps etc.

6.4 Post Installation Checklist

The following checks should be performed by the operator after installation to ensure system is functioning correctly;

1. Confirm vent hoses can freely drain, and that they are routed to a safe, clean location away from personnel and ignition sources.
2. Confirm Remote Filtered Breather is oriented as per Installation Guideline.
3. Confirm that fittings have been adequately tightened.
4. Confirm that Filtered Breather is securely anchored to equipment.

During Refuelling;

5. *Confirm discharge is venting correctly.*
6. Confirm tank overfill protection (OFP) and tank refuelling (refilling) systems operate effectively during refuelling procedure.

During Operation;

7. If practicable, verify inlet is venting correctly, either by observation during fuel discharge (draw down), or by measuring tank vacuum pressure with a drag gauge or similar device.

7 MAINTENANCE & SERVICING

It is very important that the Intake and Discharge hoses connected to the Filtered Breather are maintained in good condition (undamaged), and free of obstructions.



It is imperative the **Overfill Protection (OPF) and Tank Refuelling (Refilling) Systems** are operated and maintained strictly in accordance with the **manufacturer’s specifications**. Malfunction or improper operation and maintenance of such systems may lead to increased risk levels of hazards such as;

- Overfilling of a tank.
- Over-pressurisation of a tank.
- Fuel spillage and environmental damage.

Overfilling of a tank and the passage of liquid through the Filtered Breather is contrary to the purpose and intended function of the Breather and must be subject to a root cause analysis, and subsequent corrective and preventative actions.

The Banlaw Remote Filtered Breather itself is a serviceable product that may be maintained onsite by service personnel using only a genuine Banlaw filter replacement kit (BFV225-KIT). **Use only genuine Banlaw replacement parts**. The use of non-genuine parts will void any warranty claim and may cause malfunction or poor performance of the vent and introduce safety and equipment hazards.



The Filter Condition Indicator on the Breather should be regularly checked, and the Filter Element **promptly** replaced **prior** to any of the following;

- The (maximum) internal vacuum (i.e. external pressure) rating of the tank is reached.
- The Indicator “bar” displays **RED**.
- The required rate of liquid discharge from the tank is reduced.

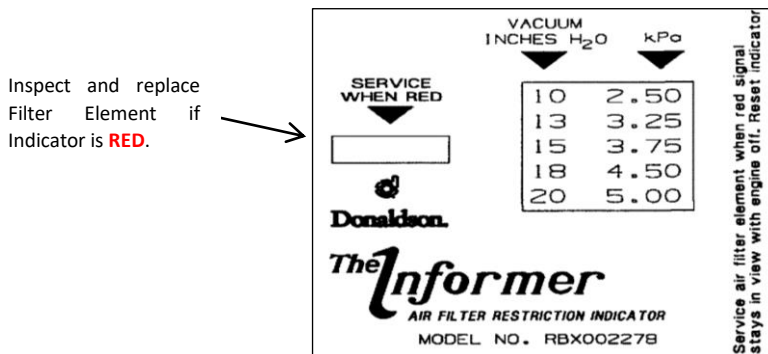

Figure 16 – Filter Condition Indicator Display

Independent testing has helped “rate” the Remote Filter Breather Element for up to **2,000 Engine Hours for Mining Plant Equipment**, and other operating environments with higher airborne contamination levels. 2,000 hours acts as only a guideline to the maximum recommended element service life. Filter Elements that consistently require replacement prior to **2,000 hours** operation may be indicative of other problems such as;

- Restrictions and blockages within the Breather Inlet (air intake) hoses and ports.
- Intake air with excessive contamination levels.
- Liquid (e.g. condensation) ingress to the Element.

7.1 Banlaw Onsite Maintenance

Clients can benefit from a **Banlaw Service Level Agreement (SLA)** to assist in the preventative and corrective maintenance of refuelling systems onsite, in addition to other diesel, fuels, oils and coolant infrastructure. This support is provided for Banlaw *and* third-party products. Clients with an SLA can *focus on their core business activities* and allow experienced Banlaw technicians and engineers to help keep such infrastructure operating at optimum *safety, performance and reliability*.

8 TROUBLESHOOTING

This section provides troubleshooting recommendations for the Banlaw Remote Filtered Breather when installed, operated, and maintained in accordance with Banlaw guidelines.

PROBLEM	PROBABLE CAUSE AND SOLUTION
Tank Not Venting during Refilling (Excessive Pressure build up)	<ul style="list-style-type: none"> • Tank Vent connected to Breather Discharge – Check to confirm correct connection of all vent lines. • Blocked Vent line – check to confirm vent lines are unobstructed i.e. no built up of Mud, Kinks or Isolation valves etc. • Fuel tank is already full – check fuel level and “open/closed” state of overfill protection system. • Tank Vent is pressurizing tank too early (prematurely) - check: <ul style="list-style-type: none"> ○ Tank Vent maximum flowrate exceeded – Reduce flowrate. ○ Tank Vent is not installed according to OEM guidelines i.e. vent is installed in a riser tube or full coupling, vent installed horizontally etc. – Refer to Vent Manufacturer’s Installation Guidelines. ○ Overly contaminated fuel passing through system, causing malfunction of the Vent and/or Level Sensor. ○ Faulty Vent – Replace Vent. • Banlaw Remote Breather Outlet Check Valve seized in closed position - Replace Breather and return to Banlaw for servicing. Check breather hoses and Diesel for adequate cleanliness.
Tank Not Venting during Decanting (Excessive Vacuum build up)	<ul style="list-style-type: none"> • Tank Vent connected to Breather Inlet – Check to confirm correct connection of all vent lines. • Blocked Vent line – check to confirm vent lines are unobstructed i.e. no built up Mud, Kinks or Isolation valves etc. • Filter element blocked – Replace filter element. • Filter or vent lines filled with fuel or condensate. Install as per installation guidelines. Check condition and correct operation of tank vent(s). • Banlaw Remote Breather Inlet Check Valve seized in closed position - Replace Breather and return to Banlaw for servicing - Replace Breather and Return to Banlaw for servicing.
Breather not filtering air (Discharge line sucking air)	<ul style="list-style-type: none"> • Tank Vent and Discharge connected to breather inlet ports – Check to confirm correct connection of all vent lines. • Breather inlet and Discharge ports swapped – Check to confirm correct connection of all vent lines. • Banlaw Remote Breather Outlet Check Valve seized in closed position - Replace Breather and return to Banlaw for servicing.

PROBLEM	PROBABLE CAUSE AND SOLUTION
Breather Inlet Discharging a <i>small</i> degree of air (Diesel or Condensate not present)	<ul style="list-style-type: none"> • Minor reverse flow through the inlet check valve is part of the normal operation of this breather. This function allows residual crack pressure of the discharge check valve to gradually equalize. Air flow should generally not be easily noticeable. Diesel or Condensate present in the inlet indicates a problem.
Breather Inlet Discharging a <i>large</i> degree of air (Diesel or Condensate present)	<ul style="list-style-type: none"> • Tank Vent and Discharge connected to breather inlets – Check to confirm correct connection of all vent lines. • Inlet Vent connected to breather discharge port – Check to confirm correct connection of all vent lines. • Banlaw Remote Breather Inlet Check Valve stuck open - Replace Breather and Return to Banlaw for servicing.
Excessive pressure drop through filtered breather during tank refilling	<ul style="list-style-type: none"> • Blocked Vent line – check to confirm vent lines are unobstructed i.e. no built up Mud, Kinks or Isolation valves etc. • Breather Outlet Check Valve is not moving freely (jamming) - Replace Breather and Return to Banlaw for servicing.
Excessive pressure drop through filtered breather during air intake (i.e. decanting of tank)	<ul style="list-style-type: none"> • Blocked Vent line – check to confirm vent lines are unobstructed i.e. no built up Mud, Kinks or Isolation valves etc. • Filter cartridge needs replacement – Replace filter cartridge. • Filter or vent lines filled with fuel or condensate. Install as per installation guidelines. • Banlaw Remote Breather Inlet Check Valve is not moving freely (jamming) - Replace Breather and Return to Banlaw for servicing.
Filters indicator “SERVICE WHEN RED” bar is red	<ul style="list-style-type: none"> • Filter element needs replacement – Replace filter element. • Inlet vent line is or has recently been obstructed – check to confirm vent lines are unobstructed i.e. no built up Mud, Kinks or Isolation valves etc. • Inspect filter element for signs of fuel or condensate ingress. Bulk fuel ingress indicates tank overfill protection system may not be working effectively. Bulk fuel or condensate build up also indicates Breather is not draining correctly. Refer to Installation Guidelines. • Maximum Breather flowrate has been exceeded – Reduce flowrate. • Indicator was not reset following previous replacement of Element.

9 OPTIONAL ACCESSORIES

The **Banlaw Remote Filtered Breather** can be configured to mount to a large variety of industrial equipment. Please consult Banlaw for further information regarding the availability of mounting hardware for your application.

The Remote Filtered breather is fitted with a 1/4” NPT-F Port. **This Port is provided to allow a pressure gauge, pressure/vacuum gauge, pressure sensor/indicator, etc. to be used to indicate internal pressure and/or vacuum (typically within the tank).** It is recommended this feature is used to allow the Operator and Service personnel to monitor these pressures, and promptly respond to problems – refer Troubleshooting (section 8).

10 PRODUCT RECYCLING & DISPOSAL

Banlaw values and supports the sustainable use of resources, and the safe, responsible and proper disposal or recycling of all materials within its products. Principal materials within the Remote Filtered Breather include Aluminium, Stainless Steel and Carbon Steel

11 PRODUCT WARRANTY

Banlaw is committed to providing quality products and services. To provide further assurance, our products and services are backed by generous warranties.

For the BRFB01A, the current Banlaw warranty term is ninety (90) days from the date of product delivery or first install, whichever expires first.

A copy of the Banlaw product warranty terms and conditions is available from Banlaw, the Banlaw website, or your nearest authorised Banlaw agent.

END OF DOCUMENT



BANLAW – UNIFIED FUEL MANAGEMENT

BANLAW OFFICES

AUSTRALIA / PACIFIC		AMERICAS / INTERNATIONAL	
HEAD OFFICE	WESTERN AUSTRALIA	NORTH AMERICA	
Phone +61 2 4922 6300	Phone +61 8 9209 1351	Phone 1 385 259 0456	
Fax +61 2 4920 6171	Fax +61 8 9209 1616	Email americasales@banlaw.com	
Email sales@banlaw.com	Email sales@banlaw.com	537 West 600 South #800	
19 Metro Court	1/16 Oxleigh Drive	Salt Lake City	
Gateshead NSW 2290	Malaga WA 6090	Utah 84101	
Australia	Australia	USA	

Website – www.banlaw.com